

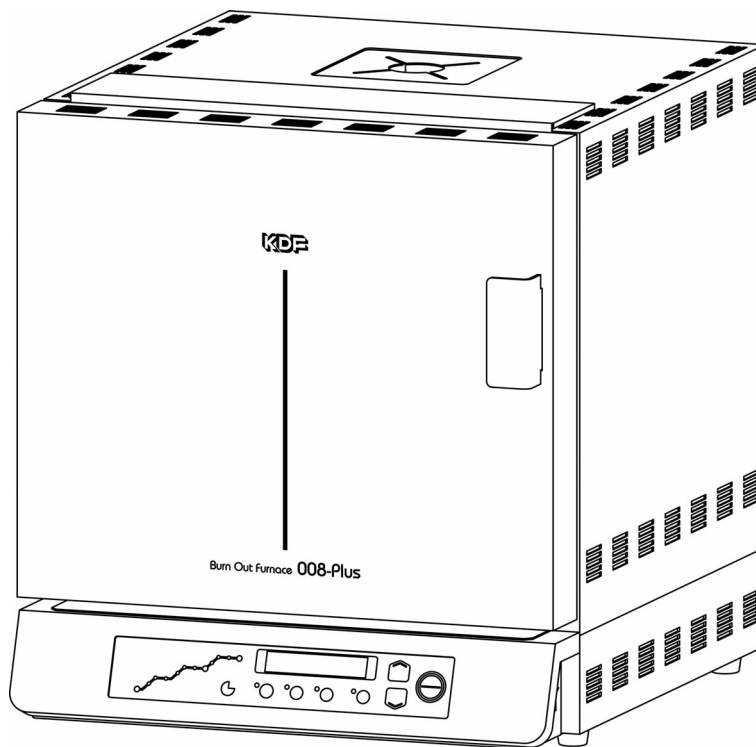

Instruction Manual

Burn Out furnace 008-Plus

Thank you for purchasing KDF's Burning out Furnace, 008Plus. Before using the unit, please read the manual thoroughly and understand the capabilities and proper usage for this machine. Please keep this manual in an easily accessible location for future reference.



DENKEN-HIGHDENTAL Co.,Ltd.

Contents

■ Safety Precautions	1
■ Before you start using your furnace	4
■ Descriptions of Component Parts	5
Furnace Front	5
Furnace Rear	6
Operation Panel	7
■ Installation	8
Power Requirement	8
Location & Environment	8
Accessory	8
Optional Item Installation	8
Air Pump Connection	8
■ Power On	8
■ Two-Stages Program Operation	9
How to program for two-stages	9
How to program for preset	10
Two-Stages Program Operation	10
Preset Operation	10
■ Three-Stages Program Operation	10
Firing of different types of investment simultaneously	10
Firing of an investment that requires a three stage process	10
How to program for three-stages	10
Three-Stages Program Operation	11
■ Quick Firing	11
Quick Firing Operation	11
■ Other Operations In Firing Process	12
Skip Operation	12
Balance Time	12
Chime Stop	12
Program change/confirmation in firing process	12
■ Pre-Stored Programs	12
■ Initial Set Mode	13
Safety Hold Time	13
Key Entry Sound Volume	13
Temperature Adjustment	13
■ Error Messages and Troubles	14
■ Optional Items	15
Catalyst Cleaner	15
Exhaust Fume Ventilator	15
■ Main Specifications	16
■ Table of Program	17

Safety Precautions

We recommend you to follow these instructions for proper use of the unit.

The safety precautions contained herein and the accompanying icons provided for the safe use of this machine and to prevent injuries and loss on material resources.
Please read them carefully prior to your actual machine operation.



WARNING

Failure to follow or ignorance of the directions may cause severe injury or death.



CAUTION

Failure to follow or ignorance of the directions may cause injuries or damages to material properties.

Directions



△ This mark requires a user to pay attention to the caution mark as shown inside or around it. The illustration on the left means "Be careful of an electric shock".



⊘ This mark means prohibited actions as shown inside or around it. The illustration on the left means "Do not disassemble".



● This mark means forced action and directions to follow as shown inside or around it. The illustration on the left means "Unplug out of power outlet".



WARNING



Unplug

In the event when there is smoke, abnormal odors or sounds, turn off the power, unplug immediately and contact the dealer for repairs.



Unplug

In the event when water enters the machine, turn off the power, unplug immediately and contact the dealer for advice. Continued use may cause electric shock or fire.



Unplug

In the event, when the machine is dropped or the furnace frame is dented, unplug immediately and contact the dealer for advice. Continued use may cause electric shock or fire.



Unplug

In case of periodic machine maintenance, unplug the power cord from the power outlet. Do not handle the plug with wet hands. Continued use may cause electric shock.



WARNING



Do Not
Dismantle

Do not remove the panels or parts uninstructed or modify them in any manner. This may cause electric shock or fire. Contact the dealer for repairs.



Prohibited

Do not place heavy items or place machine on the power cord and make sure that the cord is not damaged. This may cause fire or electric shock.



Prohibited

Leave minimum of 20cm of space around the unit as well as 1.5m of space above the unit. If not, conduct fire prevention.



Wet Prohibited

Do not allow water come in contact with equipment.



Not Designated
Volt. Prohibited

Plug to the power outlet of the designated voltage described in the main specifications. Use of any other voltage may cause fire or shock.



Wet Handling
Prohibited

Do not handle the unit with wet hands as this may cause electric shock.



Prohibited

Do not scratch, alter, bend, twist, pull and heat the cord. This may cause fire or electric shock. Contact dealer for repairs.



Prohibited

This unit is for dental casting ring firing furnace. We do not recommend you to use the unit for any other purpose.



Contact
Prohibited

When you use tongs inside furnace for casting rings in and out, do not allow tongs to touch heating element.



CAUTION



Do not let the unit door stay opened. This may cause fire or injury.

Prohibited



Before using the unit, make sure that the temperature inside muffle is below 40°C and clean the dusts inside the unit. The dusts inside the unit may cause the heater damage and electric shock.

Cleaning
inside muffle



Before using the unit, install exhaust sleeve and ceramic tray. If they are damaged, replace them immediately. The damaged accessories may cause damage of muffle and heater.

Accessory
Installation



Do not touch the highly heated area of the unit in use or soon after use. Especially, the top surface is highly heated.

Contact
Prohibited



Do not use or place anything flammable near the unit. This may cause fire or burn.

Prohibited



Check the unit for signs of parts damage prior to use and make sure the unit is in normal state. Contact the dealer for advice when you find anything abnormal.

Check Before
Use



Plug the main power cord into power outlet completely. The plug may heat up and cause fire or burns if not completely plugged in. In addition, if the metal part of plug is touched while the plug is not fully plugged in, electric shock may result.

Required



Do not place the unit on an unstable base to prevent the unit from falling and damaging. This may cause injury.

Prohibited



Unplug the main power cord from the power outlet when the unit is not in use for a long period of time.

Unplug



When you unplug the power cord from the power outlet, do not pull the cord. If the cord is damaged, fire or shock may result. Always remove by handling the plug.

Prohibited



CAUTION



The noise from the unit may occur noise into radio etc.

Caution

Before you start using your furnace

When you unpack the unit, we recommend you to make sure that the following standard accessories are included. In addition, check the unit for any damage or dent on the unit surface. Contact the dealer if there is any damage on the unit.

Accessories

Standard accessories	Ceramic Gas Outlet	1 pc
	Instruction Manual	1 pc
	Firing Tray	1 pc

We recommend you to save the carton and all packing materials for future use when there is ever a need to ship or move your equipment.

Descriptions of Component Parts

Furnace Front

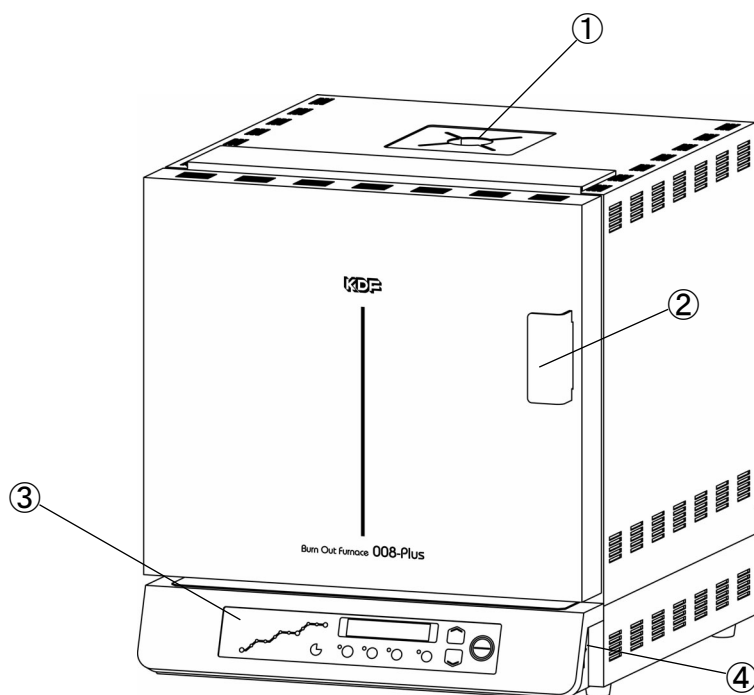

- ① Gas Vent Place the ceramic gas outlet provided for catalyst cleaner or exhaust fume ventilator.
- ② Door Knob Pull the knob to open the door and push to close.
- ③ Operation Panel Program operation, furnace temperature and program process are displayed.
- ④ Power Switch On/Off power switch.

Furnace Rear

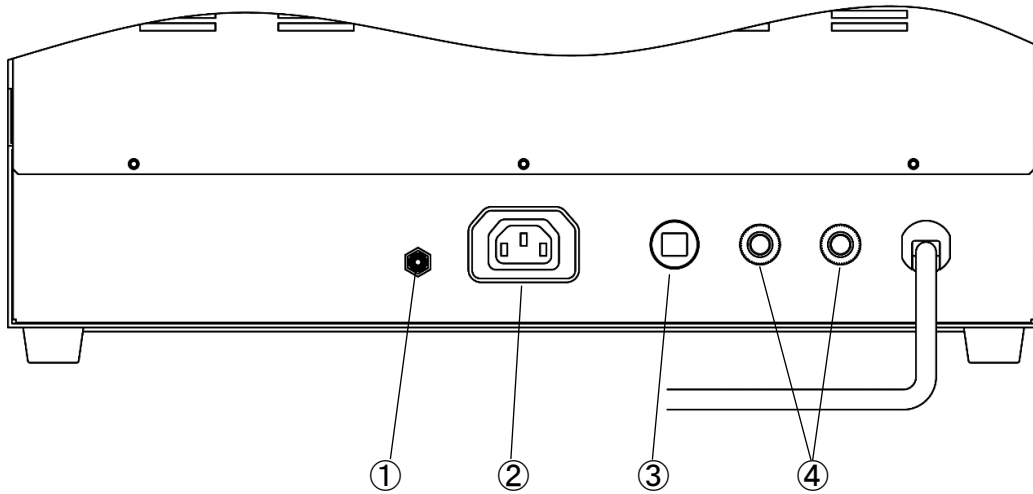

- | | |
|------------------------|--|
| ① Air inlet | Connect a piping tube for airflow. |
| ② Socket | Power outlet to plug in catalyst cleaner, KDF-ES72, or exhaust fumes ventilator, KDF-VF72. |
| ③ Sub Circuit Breaker | No fuse breaker for the socket. When over current caused the circuit breaker to trip, the breaker button will poke up. Press it to reset. |
| ④ Main Circuit Breaker | Main circuit breaker of this unit. When over current caused the circuit breaker to trip, the breaker button will poke up. Press it to reset. |

Operation Panel

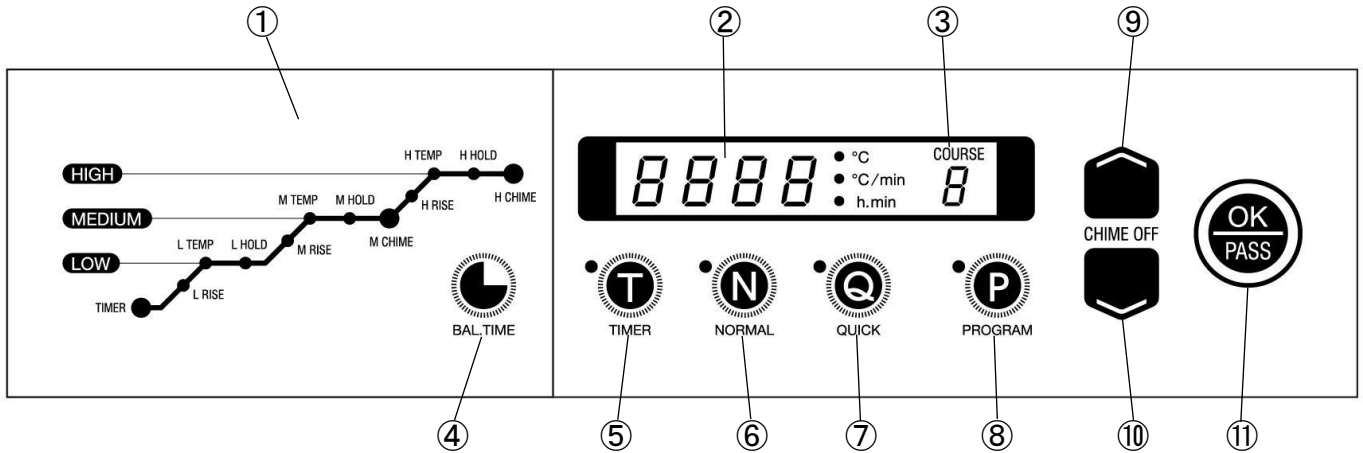

- ① Process Graph Program items are displayed when you store program and the process finished and current process are displayed during program operation.

- ② Display Temperature, heat rise speed and hour/minute are displayed. Lamp of unit measure is switched to the indication under process.

- ③ Program Course Program course or the course under process is displayed.

- ④ BAL. TIME Press to display required firing time of the course or remaining time of the course on display.

- ⑤ TIMER (T) Press to store attempted time to activate program start.

- ⑥ NORMAL (N) Press to start normal firing operation on/off.

- ⑦ QUICK (Q) Press to start quick firing operation on/off.

- ⑧ PROGRAM (P) Press to store program or to confirm and press to revise the program under process or to confirm.

- ⑨  (Up) Press to revise program course, to decrease stored numerical values or to stop chiming.

- ⑩  (Down) Press to revise program course, to decrease stored numerical values or to stop chiming.

- ⑪ OK/PASS Press to set program storage or to proceed to next program item while you store program or press to skip the program under process during operation.

Installation

Power Requirement

- We recommend you to use the proper power voltage described in the main specifications of the unit.

Location & Environment

- Set up the unit on a flat stable table.
- Keep the unit away from walls and other equipment.
Note) Leave a minimum of 20cm of space around the unit as well as 1.5m of space above the unit. If not, conduct fire prevention. Do not place anything flammable near the unit.
- Do not place anything on the top of the unit other than exclusive catalyst cleaner or exhaust fume ventilator.

Accessory

- Put the provided ceramic gas outlet into gas vent on the top of the unit.
- Place the provided ceramic tray in furnace.



Note) Be sure to use the accessories. If damaged, replace a new one.

Optional Item Installation

- Place optional catalyst cleaner or exhaust fume ventilator on the top of the unit and connect the power cord to outlet for cleaner in accordance with the instruction manual.

Air Pump Connection

- In order to fire casting ring quickly, it is available for airflow. In case of using airflow, provide an air pump for aquarium (1~2L/min.) and set up the tube as per the fig in below. Do not connect a power plug of the pump to power outlet on the back of the unit. Connect the power plug to other power outlet.

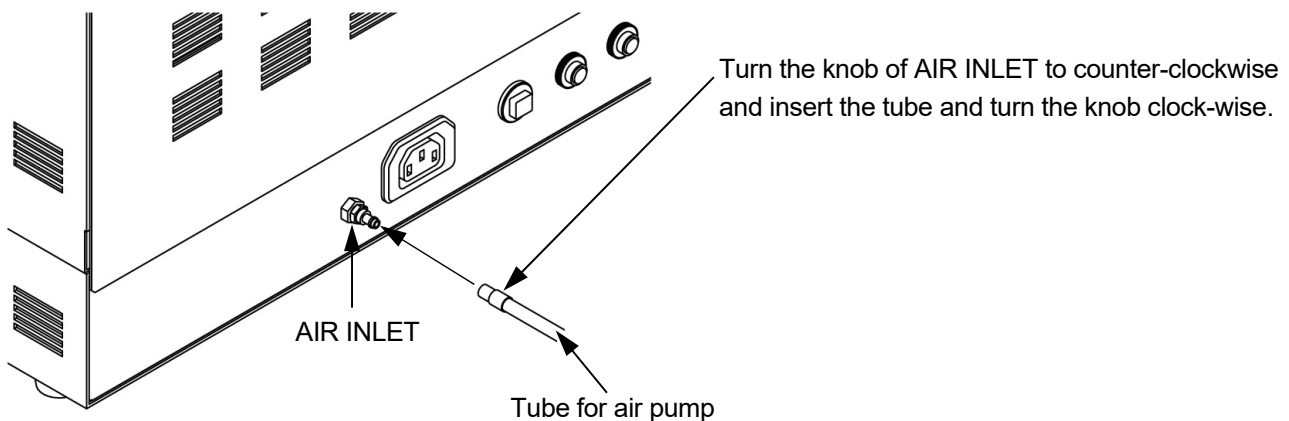

The installation is finished.

Power On

- Turn the switch on the front right side of the unit upward to power on. After **PLUS** is displayed, an existing muffle temperature is displayed.

THIS IS CALLED STANDBY MODE.

Two-Stages Program Operation

How to program for two-stages

Program Example : In general, ring molds are heat treated under two-stage firing program.

Suppose you store a firing program on program course 5 as follows.

Course	5
TIMER	8 hours 30 minutes
L RISE	6°C/min
L TEMP	300°C
L HOLD	1 hour
M RISE	11°C/min
M TEMP	700°C
M HOLD	1 hour 30 minutes
H CHIME	Large (2)

1. Turn the power switch on and press the buttons to set **5** on the program course and press the **PROGRAM** button to continue.

L Rise lamp is illuminated

2. Press the button to set **6**°C/min. on the display and press the **OK/PASS** button to continue.

L Temp. lamp is illuminated

3. Press the button to set **300**°C on the display and press the **OK/PASS** button to continue.

L Hold lamp is illuminated

4. Press the button to set **1.00** hour.min. on the display and press the **OK/PASS** button to continue.
5. M Rise, M Temp., M Hold are programmable in the same way as done in the above procedures.

M Chime lamp is illuminated

6. You have the M Chime lamp being illuminated but at this process press the **OK/PASS** button.



Note) H process is not necessary in this two-stages firing program. Set M chime volume to omit H process and the unit is able to start operation.

H Rise lamp is illuminated

7. In this example, H process is not in use and enter **PASS** on the display and press the **OK/PASS** button to set.

When H Rise lamp is illuminated, press the button to display **PASS**.

H Chime lamp is illuminated



8. Press the button to display **00-2**.

0FF	Chime off
00-1	Lower chime volume
00-2	Higher chimer volume



Select M or H chime lamp to enter chime sound volume.



How to program for preset

When you program Preset time, firing program starts operating when the set time is past. In the program example shown above, the program starts after 8 hours 30 minutes. Press the **TIMER** button in the Stand-by mode and press the   button to program **8.30** on the display.

Note) On the program course where no program is stored preset time is not available to set.

Press the **PROGRAM** button and press the **OK/PASS** button to confirm in sequence the stored program contents of the course on display. Press the **PROGRAM** button again and the furnace returns to standby mode.

Two-Stages Program Operation

1. While the furnace is in standby mode, press the   button to select your attempted program course.
(In this program example, you selected course 5)
2. Press the **NORMAL** button.

L Rise lamp blinks to start program operation.

Preset Operation

When you program Preset operation, press the **TIMER** button prior to pressing the **NORMAL** button.

In this example, with **8.30** on the display, press the **NORMAL** button and **TIMER** lamp on the Process Graph blinks. When the stored Preset time is reached, the furnace starts operating from L process.

Three-Stages Program Operation

- This three-stages firing function will help you for a simultaneous firing of cristobalite and phosphate type of investment which differ in each final temperature.

Firing of different types of investment simultaneously

- Generally L process is used in common for both types of investments due to the same temperature and hold time. We recommend you to program firing temp. of cristobalite investment on M process and that of phosphate investment on H process.
- When the Small or Large is programmed on the M chime, after M process is finished, if the **OK/PASS** button is not pressed, M Temp. keeps holding without proceeding to H process. Before moving to H process, cast cristobalite casting ring.



Firing of an investment that requires a three stage process

- When the Three-Stages Program Operation is required, program the (**FF**) on the M chime.
After M process is finished, move to L process automatically.

How to program for three-stages

1. Store the programs on L and M processes. (Refer to two-stages program storage)

M Chime lamp is illuminated



2. When M chime lamp on the process graph is illuminated, press the   button to display **FF**, **0n-1** or **0n-2** and press the **OK/PASS** button.

FF	No sound and move to H process
0n-1	Small volume and hold M temperature
0n-2	Large volume and hold M temperature



H Rise lamp is illuminated

3. Press the   button to set the H Rise temp and press the **OK/PASS** button.



H Temp. lamp is illuminated

4. Press the   button to set H temp. and press the **OK/PASS** button.

H Hold lamp is illuminated

5. Press the   button to set H hold and press the **OK/PASS** button.

H CHIME lamp is illuminated

6. Press the   button to set H chime and press the **OK/PASS** button.

When the program is stored correct, repress the **PROGRAM** button to return to standby mode.

The programming is finished. After pressing the **PROGRAM** button, press the **OK/PASS** button to confirm programmed items of course displayed.

Press the **PROGRAM** button to move to standby mode.

Three-Stages Program Operation



1. While the furnace is in standby mode, press the   button to select your intended program course.

2. Press the **NORMAL** button to start the operation.

Note) When you use the preset operation, see the "Preset Operation" in the two-stages program operation.

3. When the stored M Hold time is finished and Small or Large is stored on the M chime, M chime blinks and the programmed low chime keeps sounding.





Note) Press the   button if you want to stop the chime sounding.

Hint Note) If the **OK/PASS** button is not pressed, M Temp. keeps holding without proceeding to H process.

When the ( F F) is stored on the M chime, it not sound and proceed to H process.

4. When H process is finished, H chime lamp blinks and the chime keeps sounding for 4 minutes.



Note) Press the   button if you want to stop the chime sounding.

5. Remove the H temperature ring mold out of the furnace for casting process. Repress the **NORMAL** button to release the normal firing program.



Note) The storage of high or low temperature on each L. M. H. temperature is not limited.

You are allowed to store higher temperature on M than you store on H temperature.

In this case, the temperature cooling speed will depends on the same heat rise speed stored.

Quick Firing

This mode is to put the invested ring into muffle chamber that reached in advance the programmed firing temp. to help proceed quickly to casting process.

Note) If the investing material is not suitable for quick heat up, a hasty heat up is risky to cause breaking of the investing material due to thermal expansion.

Quick Firing Operation

Choose the programmed course of two-stages or three-stages firing and press the **QUICK** button. Heat goes up toward the highest temperature programmed in the process at the highest rise speed.

When the heat reaches the target temperature, furnace performs programmed hold time and chime sounds with the volume programmed on the H Chime when hold time is over.

Note) Even in case of quick firing operation, program contents remain unchanged.

Other Operations In Firing Process

Skip Operation

While a program is in process, press the **OK/PASS** button to skip the program in process and proceed to next program item.

Balance Time



While you press the **BAL.TIME** button, the remaining time until the end of the Hold time of the final process appears on the display.

Note) Depending on program contents or numbers of firing ring molds, the balance time on display sometimes may differ from actual balance time. This is roughly estimated time for the sake of convenience.

Chime Stop

Press the   button if you want to stop M chime or final chime while the chime is sounding.

Program change/confirmation in firing process

1. Press the **PROGRAM** button during the program operation.
2. Press the **OK/PASS** button in sequence to make sure the stored program correct. When you need to change the stored program, display the item and press the   button to change the program.
3. Press the blinking **PROGRAM** button to release the program confirmation/modification mode.

If no button operation is done in about 4 seconds, the furnace returns to the original operation display. The changed value will be stored.

Pre-Stored Programs

The following programs are pre-installed on Course No.7, 8 and 9 when shipping. We recommend you to use the programs with your investment. The values of each program are revisable with your program storage in program mode.

Course	7	8	9
Investment	Christobalite	Phosphate	Simultaneous firing of christobalite and phosphate investment
L Rise	6	9	6
L Temp.	3 10	3 10	3 10
L Hold	0.30	0.30	0.30
M Rise	10	12	10
M Temp.	7 10	8 10	7 10
M Hold	1.00	1.00	1.00
M Chime	OFF	OFF	on-2
H Rise	PASS	PASS	15
H Temp.	-	-	8 10
H Hold	-	-	1.00
Finish Chime	on-2	on-2	on-2

Initial Set Mode

Turn on the unit while you press the **PROGRAM** button to set the following programs.

- Safety Hold Time
- Key Entry Sound Volume
- Temperature Calibration

Safety Hold Time

This function is to cease supply of current to muffle heater to prevent negligence of power switch off when a certain amount of time passed after program finish. Initial value of 5 hours is stored.

- When the unit power is off, turn the power switch on while you press the **PROGRAM** button to display **5 F 5**. Press the **↑** **↓** button to revise the initial value.
- 0~9 hours is available to set. If you store the **5 F 0** the function of Safety Hold Time is off.
- Press the **OK/PASS** button to proceed to the "Key Entry Sound Volume".

Key Entry Sound Volume

Press the **↑** **↓** button to choose key entry with sound or soundless. (The sound volume set of program M and H chime is unavailable)

OFF	Both key entry and error chimes soundless
on - 1	Key entry chime sounds but error chime soundless
on - 2	Both key entry and error chimes sound

Initial Set Value : **on - 2**

- Press the **OK/PASS** button to proceed to the next item "Temperature Calibration".

Temperature Adjustment

It is capable of adjusting displayed temp. in $\pm 20^{\circ}\text{C}$ from the standard temp. 750°C .

Set with **↑** and **↓** button.

The initial value is set **5 0** (± 0 no adjusted).

- In case, temp in the chamber seems around 10°C lower than displayed temp. , set **5 10** ($+ 10^{\circ}\text{C}$).

Press the **OK/PASS** button to make sure of the initial value set.

Press the **PROGRAM** button to release the initial value set mode.

Error Messages and Troubles

When you have the errors and troubles as mentioned below, we recommend you to follow the instructions shown on each item. Contact dealers for repairs.

Items	Possible Causes of Troubles	Recommendable Measures
Power fails to switch on	Main power is not supplied to the furnace.	Make sure that power cord is plugged or main breaker is blown or not.
Err 1	Control system is malfunctioning due to noise.	Repair is recommended if often occur.
Err 2	Computer Memory Loss	Repair is recommended.
Err 3	Control system is abnormal.	Repair is recommended.
Err 6	Thermocouple breakdown	Replace a thermocouple.
Err 9	Abnormal heat rise	Repair is recommended.
Err 11	Thermocouple is abnormal or heater breakdown	Repair is recommended.
Furnace Surface is hazardous when touch	The earth line may not be grounded or insufficiently grounded.	Sufficient grounding is necessary.
Slow Heat Rise	Firing of plenty ring molds will slow heat rise.	This is not abnormal
	As temperature rises high, heat rises slow.	This is not abnormal
	Too much airflow.	Airflow is between 1~2L/min.
A low noise sounding from the heater	When muffle heat is still low, a low noise will sound.	This is not abnormal.
Temperature is not rising. Muffle heat up is slow.	Muffle heater breakdown	Repair is recommended.
	Too much airflow.	Airflow is between 1~2L/min.
Catalyst cleaner is not working.	Catalyzing is of no effect.	Replacement of catalyst is recommended.
	Sub breaker is damaged.	Remove the cause of trouble and press the circuit breaker button to reset.
Exhaust fume ventilator is not working.	Sub breaker is damaged.	Remove the cause of trouble and press the circuit breaker button to reset.

Optional Items

Catalyst Cleaner KDF-ES72

The gasses and bad smells produced while heat treating ring molds are dispersed by catalyst cleaner (Platinum Catalyst). Plug the power cord of cleaner to the dedicated power outlet on the back of main unit to operate together with the unit.

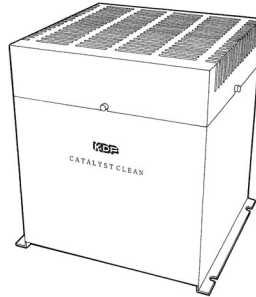

Exhaust Fume Ventilator KDF-VF72

Exhaust fumes are ventilated out of labs through the ventilation hose of 2.5 meters long provided. Plug the power cord of ventilator to the dedicated power outlet on the back of main unit to operate together with the unit.

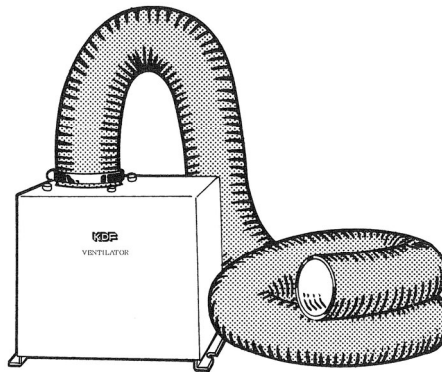

Main Specifications

Product Name	008Plus
Power Requirement	AC220-230V±10% 50/60Hz
Power Consumption	3.0kVA
Weight	35kg
Muffle Chamber	180(W) x 155(H) x 255(D) mm
Exterior Dimensions	420(W) x 465(H) x 480(D) mm
Cleaner Outlet	300VA max.
Air Inlet	Φ6 x 4 1~2L/min.
Maximum Temperature	1100°C
Environment for Setup	Room Temp. 10~40°C Humidity 30~90%RH non condensing
Program Memory Capacity	10 programs (0~9)
Firing Stage	1~3 Stages
Program Items	Preset Timer 0~99 hours 50 minutes (per 10min.) L RISE PASS, 1~20°C/min. (per 1°C), FULL L TEMP 0~1100°C (per 1°C) L HOLD 0~9 hours 59 minutes (per 1min.) M RISE PASS, 1~20°C/min. (per 1°C), FULL M TEMP 0~1100°C (per 1°C) M HOLD 0~9 hours 59 minutes (per 1min.) M CHIME OFF, Small, Large H RISE PASS, 1~20°C/min. (per 1°C), FULL H TEMP 0~1100°C (per 1°C) H HOLD 0~99 hours 50 minutes (per 10min.) H CHIME OFF, Small, Large
Accessories	Ceramic Gas Outlet 1 pc Ceramic Tray 1 pc Instruction Manual 1 pc

The specifications are changed without prior notice, in case the furnace is in need of quality improvement.

DENKEN-HIGHDENTAL Co.,Ltd.

24-3 Kisshoin Ishiharakyomichi-cho, Minami-ku, Kyoto, 601-8356, JAPAN

TEL : 81-75-672-2124 E-mail : info@denken-highdental.co.jp

Table of Program

	0	1	2	3
Investment				
Process				
L RISE (°C/min.)				
L TEMP. (°C)				
L HOLD (hour/min.)				
M RISE (°C/min.)				
M TEMP. (°C)				
M HOLD (hour/min.)				
M CHIME				
H RISE (°C/min.)				
H TEMP. (°C)				
H HOLD (hour/min.)				
H CHIME				

	4	5	6	7
Investment				
Process				
L RISE (°C/min.)				
L TEMP. (°C)				
L HOLD (hour/min.)				
M RISE (°C/min.)				
M TEMP. (°C)				
M HOLD (hour/min.)				
M CHIME				
H RISE (°C/min.)				
H TEMP. (°C)				
H HOLD (hour/min.)				
H CHIME				

	8	9		
Investment				
Process				
L RISE (°C/min.)				
L TEMP. (°C)				
L HOLD (hour/min.)				
M RISE (°C/min.)				
M TEMP. (°C)				
M HOLD (hour/min.)				
M CHIME				
H RISE (°C/min.)				
H TEMP. (°C)				
H HOLD (hour/min.)				
H CHIME				