

MASTER PLUS

Instruction Manual

Thank you for purchasing the Master Plus. Before using the Master Plus, please read the manual thoroughly and understand the capabilities and proper usage for this machine. Please keep this manual in an easily accessible location for your future reference.

Contents

Safety Precautions	1
Standard Accessories	3
Descriptions of Component Parts	4
Precautions before Use	6
Operation	9
Periodic Machine Cleaning	23
Maintenance Part Replacements	24
Error Messages	26
Specifications	27

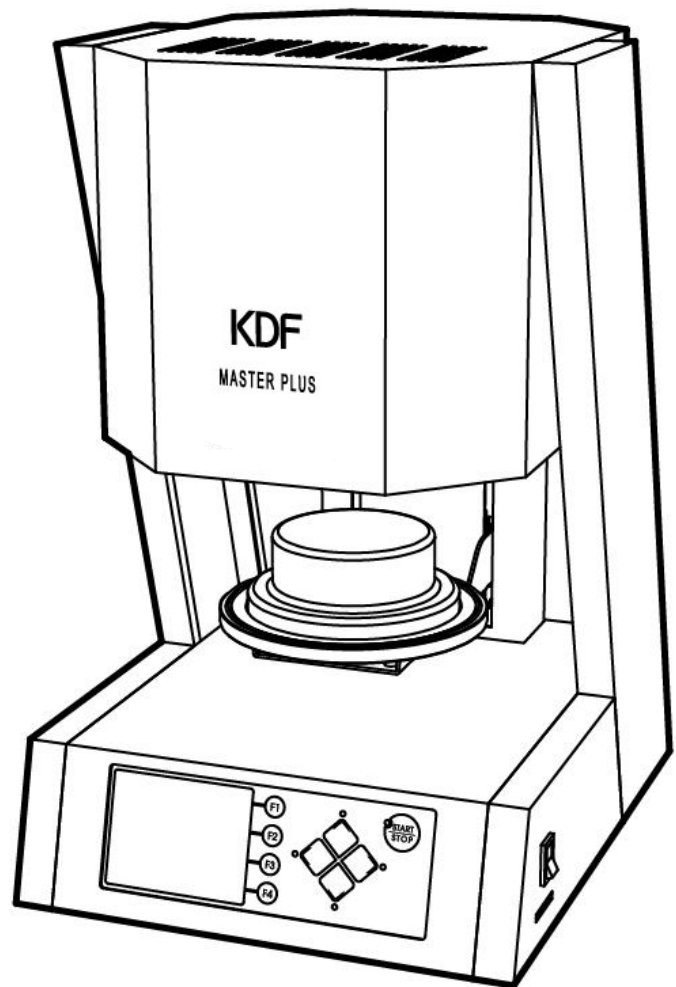

Safety Precautions

We recommend you to follow these instructions for proper use of the unit.

Directions

The safety precautions contained herein and the accompanying icons provided for the safe use of this machine and to prevent injuries and loss on material resources. Please read them carefully prior to your actual machine operation.



WARNING

Failure to follow or ignorance of the directions may cause severe injury or death.



CAUTION

Failure to follow or ignorance of the directions may cause injuries or damages to material properties.



⊘ This mark means prohibited actions as shown inside or around it. The illustration on the left means "Do not disassemble".











● This mark means forced action and directions to follow as shown inside or around it. The illustration on the left means "Unplug the power".







△ This mark requires a user to pay attention to the caution mark as shown inside or around it. The illustration on the left means "Be careful not to jam your fingers"

WARNING

	<ul style="list-style-type: none"> ● In the event when there is smoke, abnormal odors or sounds, turn off the power, unplug immediately and contact the dealer for repairs. ● In the event when water enters the machine, turn off the power, unplug immediately and contact the dealer for advice. Continued use may cause electric shock or fire. ● In the event when debris enters the machine, turn off the power, unplug immediately and contact the dealer for advice. Continued use may cause electric shock or fire.
	<ul style="list-style-type: none"> ● Do not remove the panels or parts uninstructed or modify them in any manner. The uninstructed disassembly may cause electric shock or malfunction.
	<ul style="list-style-type: none"> ● In the event when the machine is dropped or the frame is dented, unplug immediately and contact the dealer for advice. Continued use may cause electric shock or fire.
	<ul style="list-style-type: none"> ● Do not block ventilation at top, left, and right sides to prevent the temperature increases inside the unit. Continued use may cause fire or malfunction.
	<ul style="list-style-type: none"> ● Plug to the power outlet of the designated voltage described in the main specifications. Use of any other voltage may cause fire or electric shock.
	<ul style="list-style-type: none"> ● Keep the unit away from other equipment and walls. Leave minimum of 10cm of space around the unit. Do not place anything on the top of the unit to prevent temperature increase inside the unit. Continued use may cause fire or malfunction.
	<ul style="list-style-type: none"> ● Do not place heavy items or the unit on the power cord. This may cause fire or electric shock. ● Do not scratch, process, bend, twist and pull the power cord. This may cause fire or electric shock.
	<ul style="list-style-type: none"> ● When the unit is used, the firing stand provided must be set on the firing table. Continued use without the firing stand may cause burn or fire or breakdown.

CAUTION

	<ul style="list-style-type: none"> ● Unplug the main power cord from the power outlet when the unit is not in use for a long period of time. ● In case of periodic machine maintenance, unplug the power cord from the power outlet.
	<ul style="list-style-type: none"> ● Do not handle the unit with wet hands. This may cause electric shock. ● When you unplug the power cord from the power outlet, do not pull the cord. If the cord is damaged, it may cause fire or electric shock. Always remove by handling the plug.
	<ul style="list-style-type: none"> ● This machine is for dental porcelain firing. We recommend you to not use the unit for any other purposes.
	<ul style="list-style-type: none"> ● When moving the unit turn off the unit and unplug the main power cord to prevent damage of the cord and fire.

Standard Accessories

When you unpack the machine, we recommend you to make sure that the following standard accessories are included. In addition, please check the machine for any damage or dent on the unit surface. Contact the dealer if there is any damage on the unit.

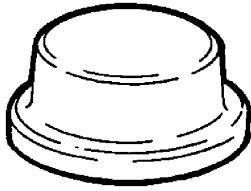

Firing Stand 1pc

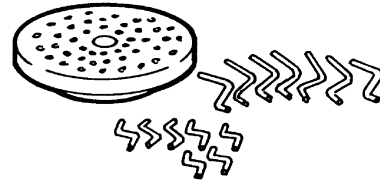

Firing Tray Kit 1set

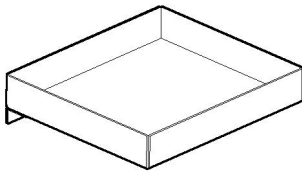

Ceramic Tray Stand 1pc

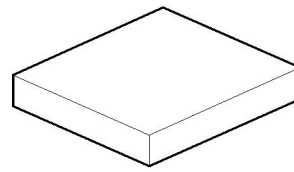

Ceramic Tray 1pc

SD Card 1pc
Instruction Manual 1booklet

We recommend you to save the carton and all packing materials for future use when there is ever a need to ship or move your equipment.

Description of Component Parts

● Front View

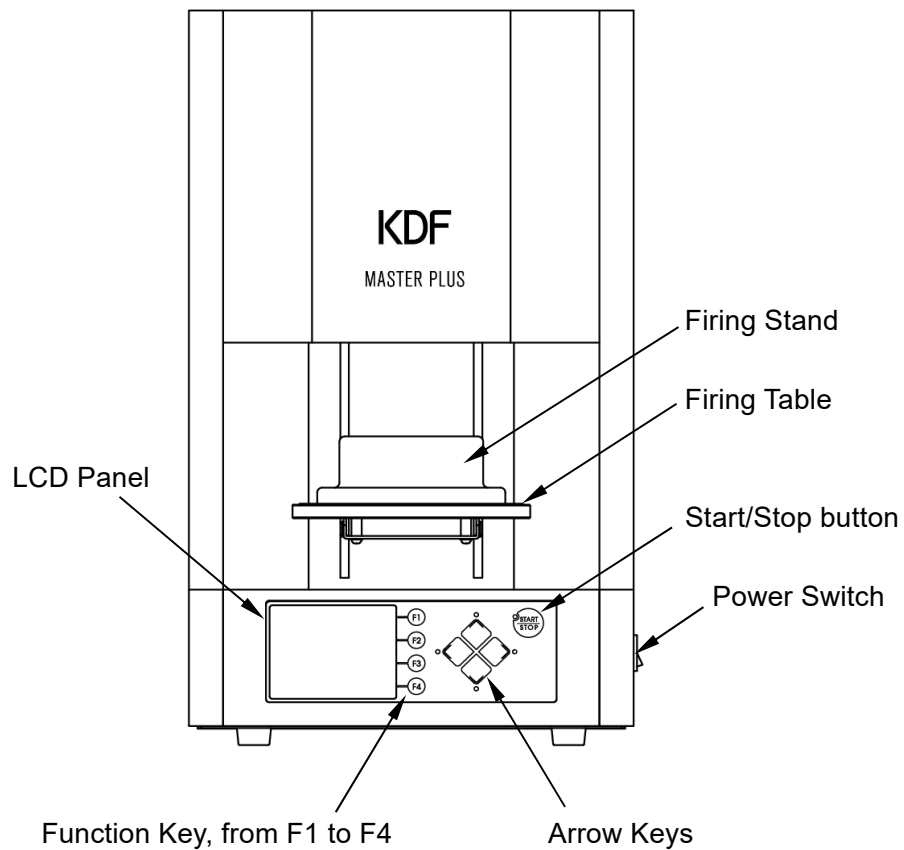

Firing Stand : A firing stand used to place the firing tray and firing objects.

Firing Table : A table used to place the firing stand, move up/down.

Start/Stop Key : A key used to start/stop firing and return from night mode to dry mode.

Power Switch : The power switch for the unit.

LCD Panel : A LCD panel that allows you to process the unit.

Arrow Keys : Keys used to change functions of modes, move the table up/down, stop, and change courses, values and settings.

Function Key : Keys used to move to modes with the F1, F2, F3 and F4.

● Backside View

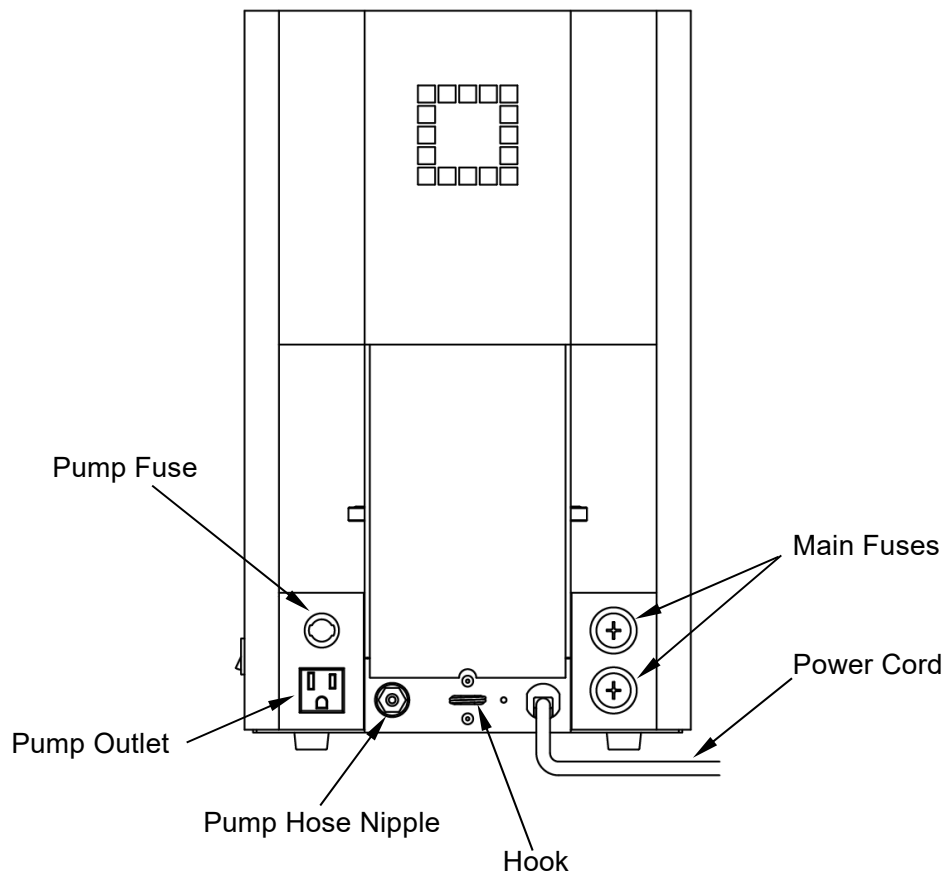

- Main Fuses : Main fuses for the unit. Φ 10.3-30A glass fuse.
- Pump Fuse : Vacuum pump fuse. Φ 5.2-10A over current fuse.
- Pump Outlet : 120V vacuum pump outlet. (Max. 400VA)
- Pump Hose Nipple : Nipple that connects the pump hose.
- Hook : Used to prevent the unit from falling down. Tie down the unit.

Precautions before use

Location & Environment

- Set up the unit on the center of a flat stable table.
- Leave a minimum 10cm of space around the unit.
Keep the unit away from walls and other equipment.
Do not place anything on the top of the unit.
- Secure the unit with the hook on the back of the unit to prevent turnover or drop.

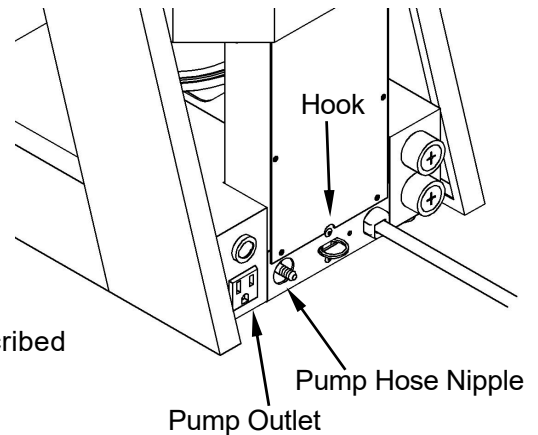

Power Requirement

- Plug to the power outlet of the designated voltage described in the main specifications.

Piping of Vacuum Pump

- Plug the vacuum pump to the Pump Outlet and connect the vacuum pump hose to the Hose Inlet.

Installation of Ceramic Tray Stand

- Place the ceramic tray inside the ceramic tray stand. It is possible to connect the ceramic tray stand at either sides of the unit.

Power Frequency Setting

- When turning the unit on for the first time, the following display will appear on the LCD panel, then set the power frequency according to your area.

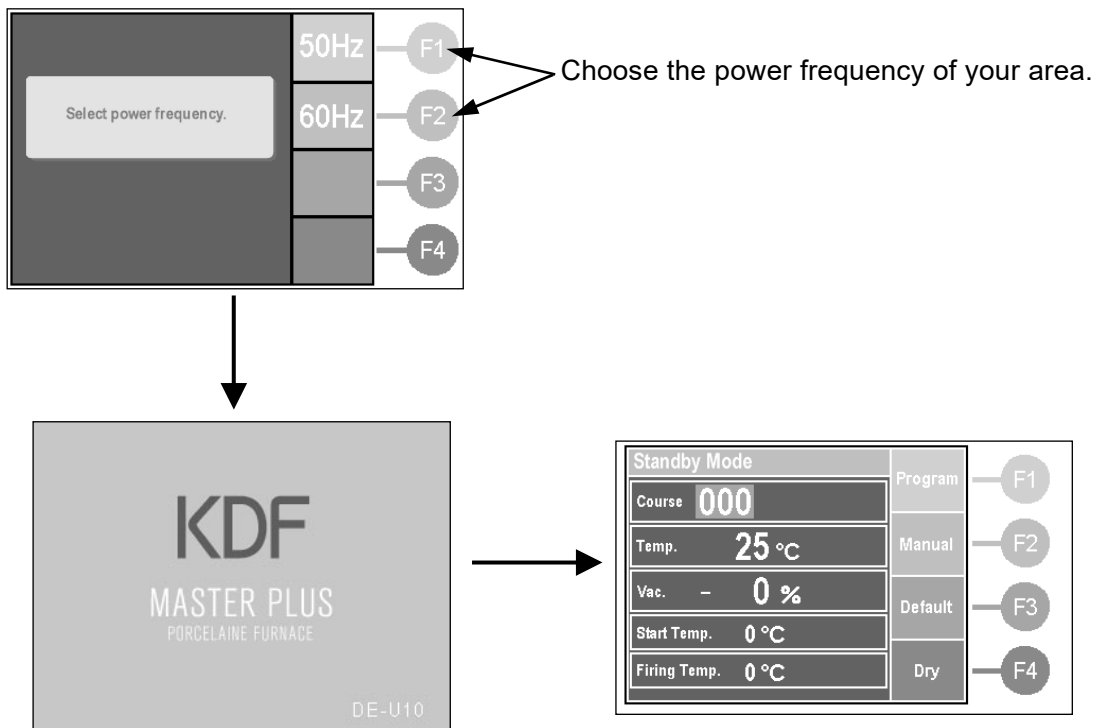



Installation of Ceramic Stand

- Press the  button to lower the table.
- Place the provided ceramic stand at the center of the firing table.

Altitude Setting

- When using the unit, please set the altitude according to your geographic location.
- For users using at high altitude, storms approaching may cause vacuum trouble.

Please follow the process listed below.

- ① When it goes into standby mode, move the “Default” button to move to default set mode.
- ② Press the   button to move to the “Altitude” and set value according to the altitude of the location. There are 4 set values : 500m, 1000m, 1500m, 2000m, Default is 500m.
The suggested value setting is as follows : Less than 500m = 500m, 500 ~ 1000m = 1000m, 1000~ 1500m = 1500m, above 1500m = 2000m.

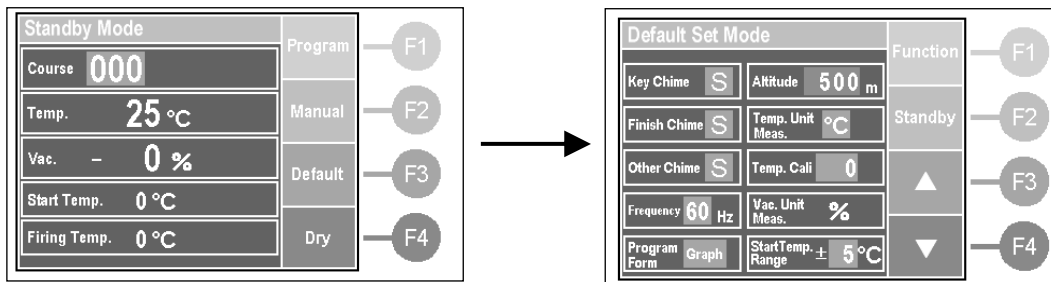

The unit installment process is completed now. When using the unit for the first time, please follow the "Unloaded Muffle Firing" process.

Unloaded Muffle Firing



CAUTION

We recommend using Dry type vacuum pump, as water puts in a pump. In case of using an oil-sealed vacuum pump, change its oil after unloaded muffle firing.

- When first purchasing the unit or when the unit has not been in use for a long period of time, there may be some moisture in the muffle that may cause bad effects during firing. Please follow the unloaded muffle firing process listed below.
- ① Power on the unit, when it goes into standby mode, press the “Default” button to go to default set mode.
 - ② When it goes into default set mode, press the F1(Function) button to change the function of F2 to F4 button, and press F4(Maintenance) button to go into maintenance mode.
 - ③ When it goes into maintenance mode, press the "Muffle Firing" button and the firing will begin.
 - ④ During firing, the screen below will appear indicating time remaining of firing. This firing process will take about 200 minutes. If you would like to cancel the firing process, press the "Cancel" button.
Caution) When firing, please have the vacuum pump set-up. If the vacuum pump is not set-up, there may be situations when the moisture is not fully pulled out.

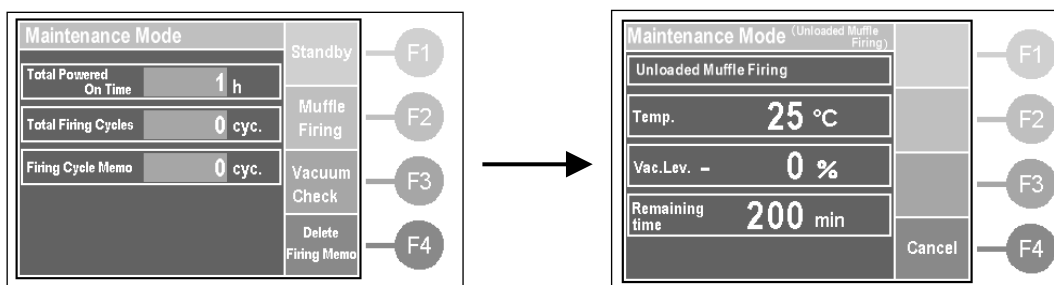

⑤ When the firing process is finished, the screen below will appear. Please press the “Cancel” button.

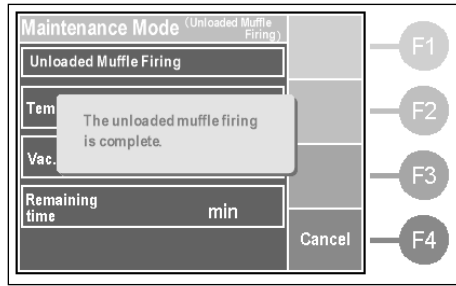

The unloaded muffle firing process is complete.

Operation

Standby Mode

- After powering on, the unit start display will appear and go into standby mode. It is possible to access other modes from the standby mode. Please see the following instruction for the standby mode below.

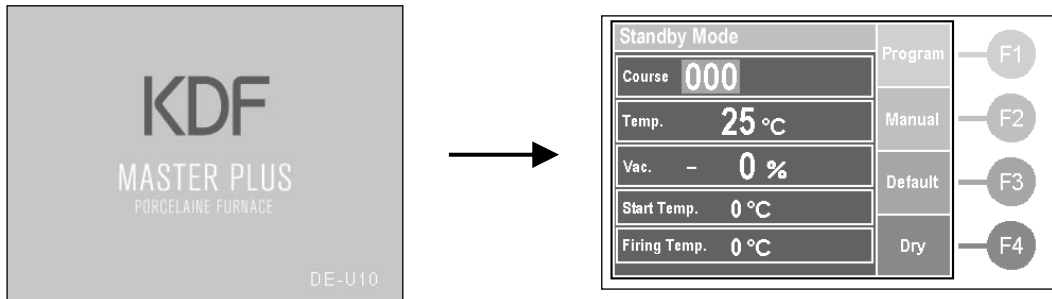

Porcelain name is displayed.

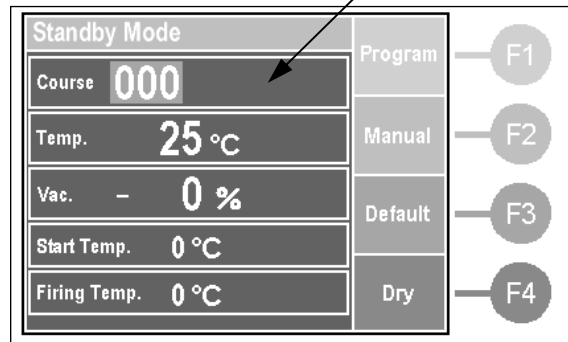

1. Course

Displays the current course number and also functions as a button to change course.

2. Porcelain Name

Displays the current porcelain name inputted into the course number.

3. Temperature

Displays the current temperature.

4. Vacuum

Displays the current vacuum level.

5. Start Temperature

Displays the current start temperature inputted into the course number.

6. Final Temperature

Displays the current final temperature inputted into the course number.

7. Function Keys

Press the F1 button to go to the program mode. →P11

Press the F2 button to go to the manual mode. →P18

Press the F3 button to go to the default set mode. →P20

Press the F4 button to go to the dry mode. →P20

- Holding Start Temperature :

This mode holds the start temperature inputted into the current course number.

Once the start temperature range (→P21) is achieved, chime will go on.

Caution) When the start temperature is held for 5 minutes, the table will automatically move up to prevent heat loss.





It is possible to set whether or not to hold the start temperature in the subprogram mode. →P15

• Up/Down Operation of Firing Table : Press the   buttons to move the table up/down and press the   buttons once again to stop moving up/down.

• Course Change : Press the   button to change the course.





Hint

It is possible to fast-forward the course number by pressing the   buttons.



Hint

It is possible to select the course from the course list by pressing   buttons at the same time. →P14

Program Mode

- This unit has 500 courses(course No.0 to 499) of 1 step firing program and 30 courses(course No.500 to 529) of 2 step firing program.

2 step firing program is able to fire 2 step of temperature rising and firing.

- Programmable parameters and program instructions

Parameter	Programmable Values	Default
Course	Programmable course number 000~499	000
Porcelain Name	Character max : 1 byte up to 8 characters, Character input : Alphabet and number	_____
Vacuum Level	0~-100% ※When set -100, continuous vacuum	0%
Start Temperature	0~900°C	0°C
Dry Time	0 : 00~99 : 59 (min : sec)	0 : 00
Muffle Dry	0 : 00~99 : 59 (min : sec)	0 : 00
Vacuum Temperature	0~1200°C	0°C
Temperature Rise	0~99°C/min ※When set 0, the temperature will rise at the fastest speed without controlling.	0°C/min
Vacuum Release Temperature	0~1200°C	0°C
Vacuum Hold Time	0 : 00~99 : 59 (min : sec)	0 : 00
Final Temperature	0~1200°C	0°C
Hold Time	0 : 00~99 : 59 (min : sec)	0 : 00
Vacuum Temperature2	0~1200°C ※course 500-529 only	0°C
Temperature Rise2	0~99°C/min ※course 500-529 only ※When set 0, the temperature will rise at the fastest speed.	0°C/min
Vacuum Release Temperature2	0~1200°C ※course 500-529 only	0°C
Vacuum Hold Time2	0 : 00~99 : 59 (min : sec) ※course 500-529 only	0 : 00
Final Temperature2	0~1200°C ※course 500-529 only	0°C
Hold Time2	0 : 00~99 : 59 (min : sec) ※course 500-529 only	0 : 00
Rapid Cooling Temperature	0~1200°C ※For firing low fusing temp. porcelain. After firing is completed, the firing table descends to cool down up to the programmed temp.	0°C
Cooling Temperature	0~1200°C ※For firing low fusing temp. porcelain. Temp. is up/down from Rapid cooling temp. to Cooling temp. by cooling time.	0°C
Cooling Time	0 : 00~99 : 59 (min : sec) ※This is required time from Rapid cooling temp. to Cooling temp.	0 : 00
Cool Time	0 : 00~99 : 59 (min : sec) ※After firing is completed, the firing table descends up to the cooling position to cool down for cooling time.	0 : 00

※Start Temperature ≤ Vacuum Temperature ≤ Vacuum Release Temperature ≤ Final Temperature
≤ Vacuum Temperature2 ≤ Vacuum Release Temperature2 ≤ Final Temperature2 (essential)

※Vacuum Hold Time ≤ Hold Time, Vacuum Hold Time2 ≤ Hold Time2 (essential)

※Programmed Cooling time has been passed at Cooling process, and Process is maintained until corresponding to Cooling temp.

- Vacuum level unit of measure :

Unit	Value											
%	-99	-98	-96	-94	-92	-90	-88	-86	-84	-82	-80	-78
kPa	-99	-98	-96	-94	-92	-90	-88	-86	-84	-82	-80	-78
hPa	-990	-980	-960	-940	-920	-900	-880	-860	-840	-820	-800	-780
cmHg	-75	-74	-72	-71	-69	-68	-66	-65	-63	-62	-60	-59
inchHg	-29.5	-29.1	-28.3	-28.0	-27.2	-26.6	-26.0	-25.6	-24.8	-24.2	-23.6	-23.0
bar	-0.99	-0.98	-0.96	-0.94	-0.92	-0.90	-0.88	-0.86	-0.84	-0.82	-0.80	-0.78

- How to program : We will program the following parameters on course No.225 to store the example.

Porcelain Name	KDF PLUS
Vacuum	-96%
Start Temperature	550°C
Dry Time	3 : 00
Muffle Dry	0 : 00
Vacuum Temperature	550°C
Heat Rate	58°C/min
Vacuum Release Temperature	750°C
Vacuum Hold Time	0 : 00
Final Temperature	800°C
Hold Time	5 : 30
Rapid Cooling Temperature	0°C
Cooling Temperature	0°C
Cooling Time	0 : 00
Cool Time	2 : 30

How to access to program mode : Press the "Program" button during standby mode.

You can input values by table type or graph type in Program mode.

You can choose whichever you like.

Default setting is "Graph" type.

You can switch the type of program mode in "Default Set Mode".

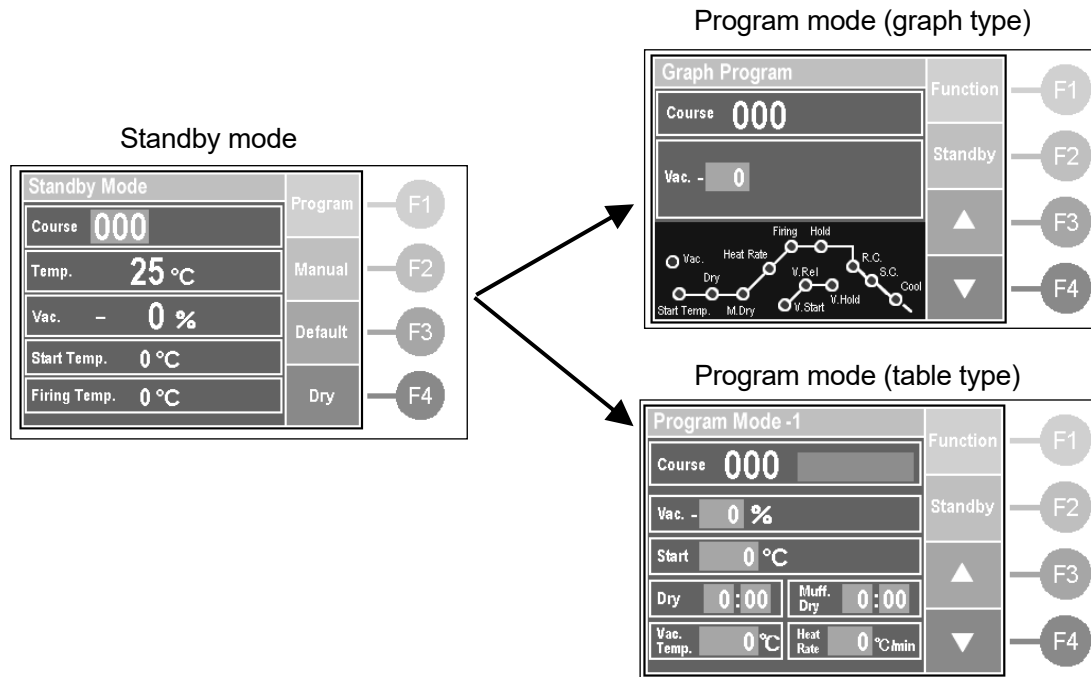

Function Keys :

In the Program Mode, Multiple Functions are assigned to F2 to F4 keys, and those functions are changed by pressing F1 key.

The default functions assigned to F2 to F4 keys :

- F2 : Go to the standby mode
- F3 : Increase the value.
- F4 : decrease the value.

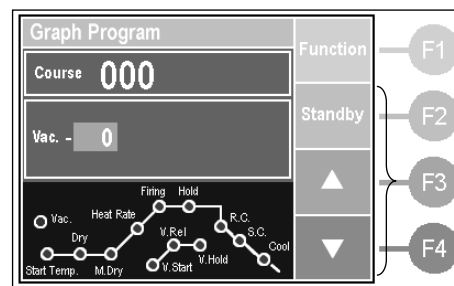



Change F2-F4 functions by pressing F1 key.

The 2nd functions assigned to F2 to F4 keys :

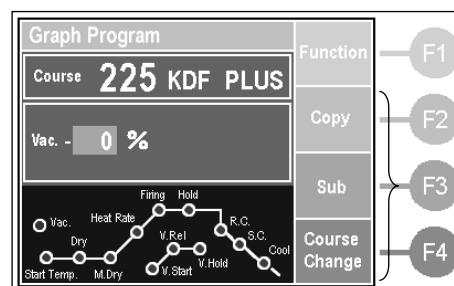
- F2 : Move to copy mode
- F3 : Move to sub program mode
- F4 : Move to course select mode





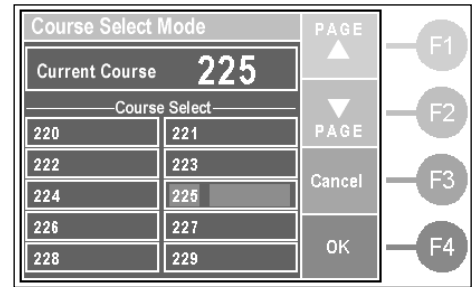

How to select program course

- ① Change the function of F2 to F4 key by Pressing the F1 "Function" key , and Press F4 "Course Change" key to move to course select mode.
- ② Once the course select mode is displayed, press the F1 "▲PAGE" or F2"▼PAGE"key to increase/decrease course number in increments/decrements of 10.
- ③ Press the   button to move course you want to select. Press the "OK" button to return the program mode and the selected course is displayed.
If you do not want to save, press the cancel button.



How to program value

1. Input porcelain name

- ① Press the   button to move to "Porcelain Name" and Press the ▲▼ button to appear the porcelain name input display.
- ② Press the   button to move to character which you want to input.





When you want to input space, move the cursor to the space next to 9. Then press the "Select" button.

Press the "Delete" button to delete one letter.

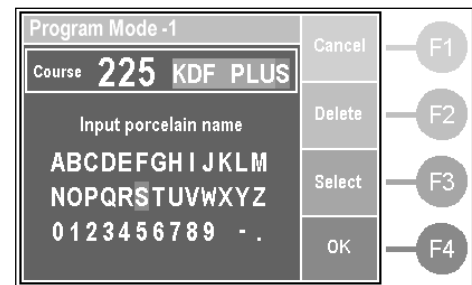
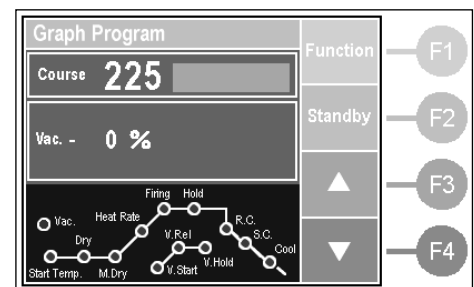
- ③ Once the input is finished, press the "OK" button to exit program mode. If you do not want to save the program, press the "Cancel" button.



2. Input vacuum level



Press the   button to select vacuum and press the ▲▼ button to change the level.

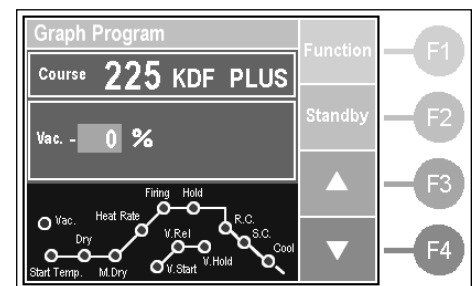

When the vacuum level is set to -100, vacuum is continuously on.



3. Input other values

It is the same input method as the vacuum level. Press the   button to select item which you want to input, and press the ▲▼ button to input values.

How to exit program mode : Once the input is finished, press the "Standby" button to move to standby mode.

※When the unit is powered off during program, the parameters will not be stored.

Subprogram Mode

- Subprogram mode : The subprogram mode is available in normal mode for additional setting.
Listed below is the setting instruction and program procedure, set according to your intention.

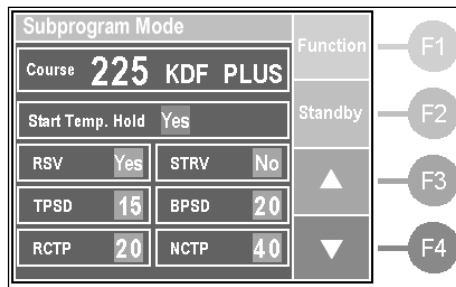

Holding Start Temperature :

No, Yes

Set whether or not to hold the start temperature

Default : Yes

Recovery Setting of Vacuum (RSV) :

No, Yes

When the vacuum is pulling, once it reaches the set vacuum level and the vacuum level goes wrong, set to start the vacuum again or not.

Default : Yes

Setting of Temperature Rise without Vacuum (STRV) :

No (Same time as vacuum), Yes (once it reaches set vacuum level)

Set to raise the temperature at the same time the vacuum starts pulling or raise the temperature once it reaches the set vacuum level.

Default : No

Top Position Setting of Dry (TPSD) :

0~95

Table start position during dry

Default : 15

Bottom Position Setting of Dry (BPSD) :

0~95

Table end position during dry

Default : 20

Rapid Cooling Table Position (RCTP) :

0~95

Table position during rapid cooling

Default : 20

Normal Cooling Table Position (NCTP) :

0~95

Table position during normal cooling

Default : 40

※The highest position is 95, lowest position is 0. The table will stop at one of 100 divided locations as shown on the sketch.

Drawing 1

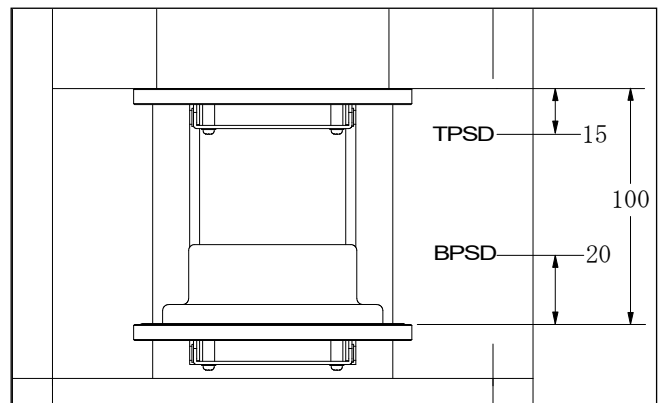

- How to access to subprogram mode : Press F1 “Function” button to change the function assigned F2 to F4 buttons, and press “Sub” button during program mode to move to subprogram mode.

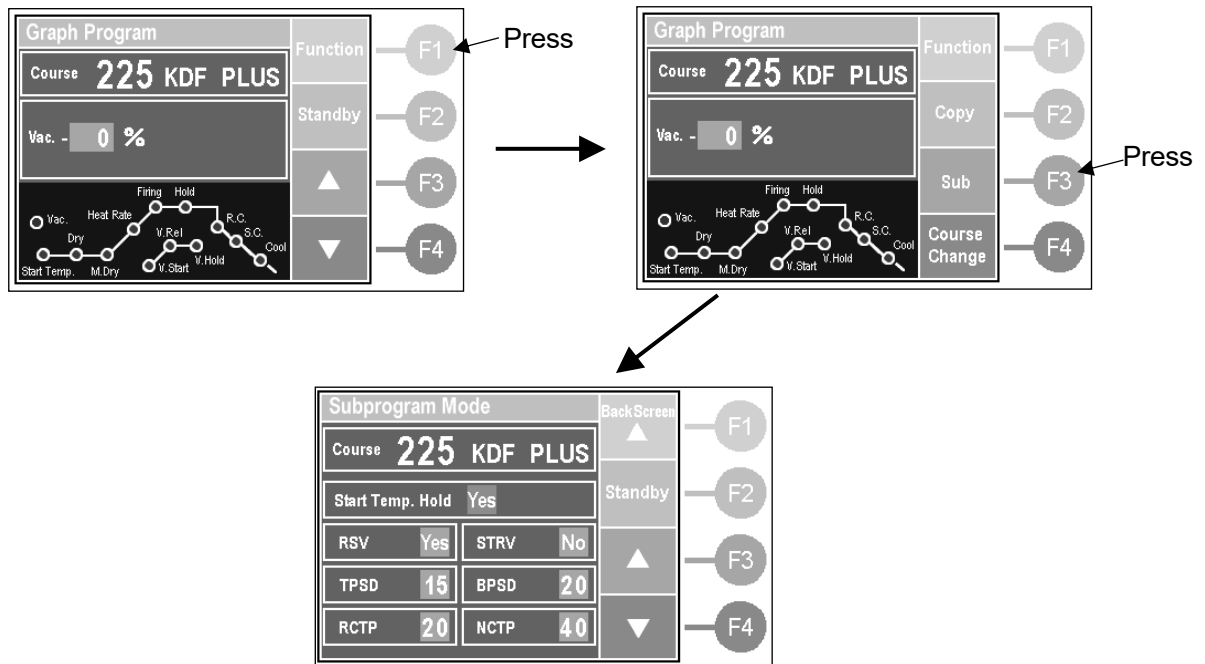

- How to input values : Press the button to move to each values and press the button change the values.
- How to exit subprogram : Once the input is finished, press the “Back Screen” button to move back to program mode. Press the “Standby” button to move to standby mode.
 ※When the unit is powered off during program, the parameters will not be stored.

Firing Mode

- We will now actually perform firing using course 225.
 - ① In standby mode, press the button and select course 225.
 - ② Once the current temperature reaches the start temperature, move the table to its lowest position.
 - ③ Once the table reaches the lowest position, place the firing object onto the firing tray and place both onto the firing stand.
 Caution) Please place the firing tray on the middle of the firing stand.
 Caution) The firing stand and the muffle will be hot. Be sure to use the tongs and not with your hands when placing the firing object onto the firing stand. There is a risk of getting burned.
 - ④ Press the “Start/Stop” button and the firing screen will be displayed and firing will begin.

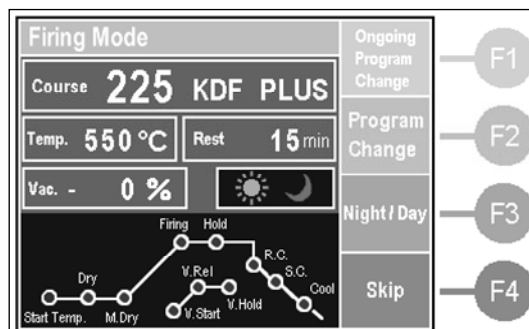

- Firing Mode Display

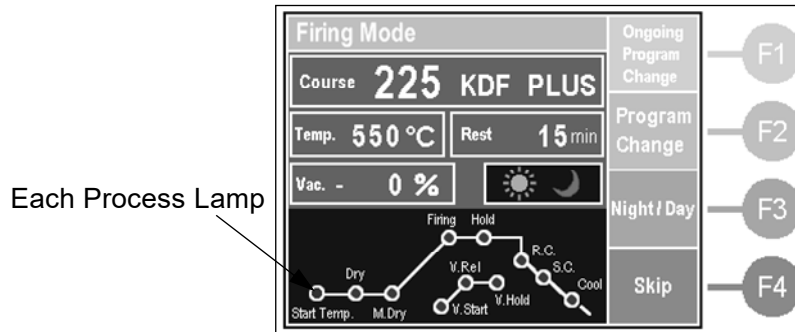

Night/Day Mode Display : When setting day mode, the ☀ will appear. When setting night mode, the 🌙 will appear.

Each Process Lamp : While processing, each process lamp will blink.

Function Button : Press the “Function” buttons to move to each mode.

- Skip button : Press this button to pass the process.
- Program change button during firing : Press the “Ongoing Course Change” button to move to program changing mode. This will not change the original inputted program setting. Please see page 12 for more information. Press the “Firing Screen” button to finish it. Caution) Do not change values when you confirm program.
- Program change and check : Press the “Program Change” button to change program except program during firing. This will not change program during firing. Please see page 12 for more information.
- Exit firing : As soon as firing program is completed, the firing table descends to the lowest position, then the heater turns OFF. The verification screen is displayed, so press Standby key to move to Standby mode.

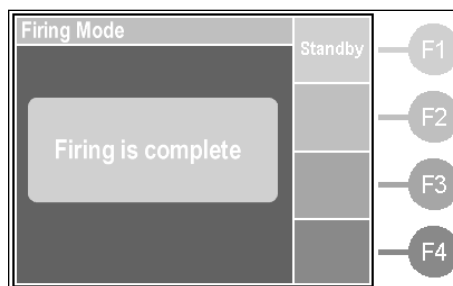





- Night Mode : Press the “Night/Day” button to change modes. Once it goes into night mode, after firing, the LCD will become dim. Press the “F1” or “Start/Stop” button to exit the night mode.

Manual Mode

- Please use this mode to program firing temperature, vacuum level and temperature rise manually.
- We will program the following parameters for example.

Firing Temperature	870°C
Vacuum Level	97%
Heat Rate	50°C/min

How to access manual program mode : Press the “Manual” button during standby mode to access to manual mode.

How to program : Press the “Program” button during manual mode to access to program mode and press the     button to input values. Once the input is finished, press the “Program Cancel” button.

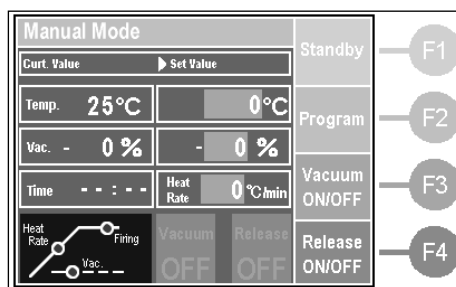

Firing by Manual Mode

- ① Press the “Start/Stop” button during manual mode and the firing screen will be displayed and firing will begin.

The display time is remaining time before the firing temperature is reached.



Once it is reached, the display time is elapsed.

 *Hint* When the current temperature is higher than inputted temperature, the ---:-- is displayed.

- ② Press the “Vacuum On/Off” button to start/stop a vacuum operation. Vacuum is started when the table is at the highest position. When the “Vacuum Off” button is pressed during vacuum operation, the continuous vacuum operation will not work.
- ③ Press the “Release On/Off” button whether or not to return air inside muffle. When the “Release On” button is pressed, air will be returned into the muffle.

 *Hint* The F3 and F4 buttons will work on screen during operation.

- ④ During manual mode operation, the table up & down is available.

 *Hint* When the  button is pressed during vacuum, air is returned into the muffle and the table moves down.

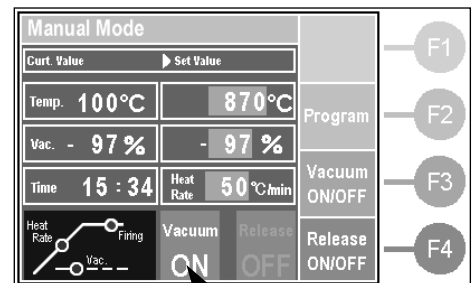

Vacuum Operation

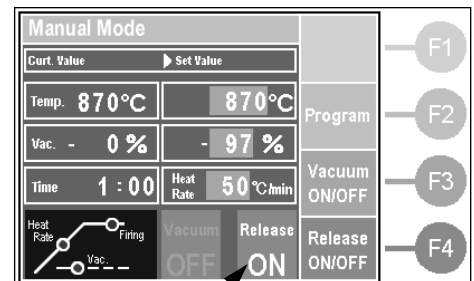

Release Operation

- ⑤ Press the “Program” button during operation to change parameters. Please see page 18 for more information. Press the “Program Cancel” button to return the operation screen.
- ⑥ Press the “Start/Stop” button to finish the firing.

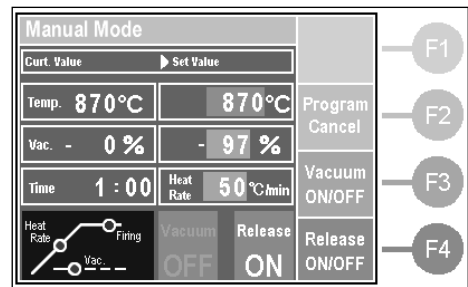

- How to exit manual mode : Press the “Standby” button during manual mode to move to standby mode.
- Programmable parameters and program instructions for manual mode

Parameter	Programmable Values	Default
Current Temperature	0~1200°C	_____
Current Vacuum Level	0~-99%	_____
Time	--:-- , 00:00~99:59 (min:sec)	_____
Firing Temperature	0~1200°C	0°C
Vacuum Level	0~-100%	0%
Temperature Rise	0~99°C/min	0°C/min
Vacuum Operation	Vacuum ON, Vacuum OFF	Vacuum OFF
Release Operation	Release ON, Release OFF	Release OFF

Copy Mode

- How to access to copy mode : Press the “Copy” button during program mode to move to copy mod.

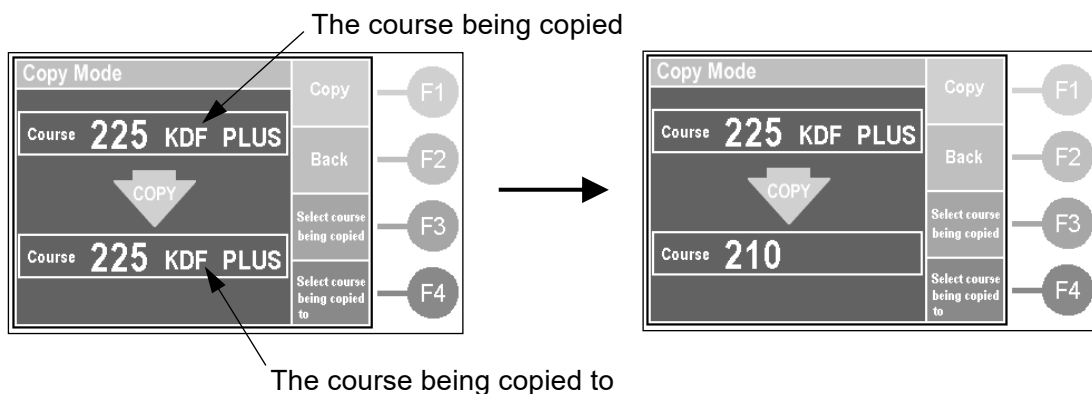

- How to use copy mode : We will copy the course 225 to course 210 as follow.
 - ① After moving to copy mode, the screen shown above will be displayed.
 - ② The bottom course will be the course being copied to. Select course 255. See the “How to select program course” on the page 14 for more information.
 - ③ After moving back to copy mode, press the “Copy” button to start the copy.

- ④ Once the copy is finished, the screen shown below will be displayed.

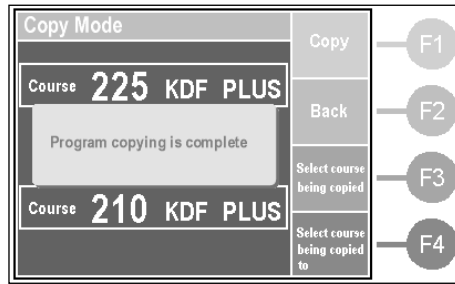

- ⑤ Press the “Back” button to move to program mode or stop the copy.

Dry Mode

- Dry Mode : This unit has a dry mode to prevent moisture inside the muffle. By running this mode when not in use during work or during the night will prevent moisture. During dry mode, muffle temperature will be kept at around 200°C.
 - ① Press the “Dry” button during standby mode to move to dry mode.
Caution) The firing table will move up automatically except the table is at highest position.
 - ② Press the “Start/Stop” button to cancel this mode.

Default Set Mode

- Default Set Mode : This mode is to set each operation default value and operation process. It is also possible to move to maintenance mode and SD card mode from this mode.
- How to access default set mode : Press the “Default” button during standby mode to move to default set mode. The screen shown below will be displayed. Press the “Standby” button to move to standby mode.

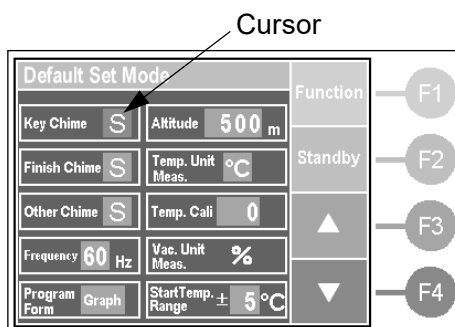

- How to change values : Press the button to select value and press the button to change value.

Chime Volume : There are 4 set values: No, S, M, L, Default is S.

- ① Key chime
Set the sound volume when buttons are pressed.

- ② Finish chime
Set the sound volume when firing is finished and when an error happens.
- ③ Other chime
Set the sound volume when the unit is powered on and when it reaches start temp.

Altitude : Set according to the altitude of the location when this unit is being used.
See the "Altitude Setting" (page 7) for more information.

Temperature Unit Measure : Available at setting °C (Celsius) or °F (Fahrenheit).
The default is °C (Celsius).

Temperature Calibration : You can perform temperature calibration of inside the muffle. The value is $\pm 30^{\circ}\text{C}$ and it is set on the basis of 1000°C . For example, when the muffle is at temperature of 1000°C and you want to raise it by 20°C , set the value 20. It will be calibrated as half at 10°C at 500°C .

Power Frequency : Set the power frequency according to your area.

Program Form : Select the program form whichever you like(Graph type or Table type).

Start Temperature Range : Set $\pm 20^{\circ}\text{C}$ of start temperature. Once the unit is reached at $\pm 20^{\circ}\text{C}$ range of start temperature, it will go to dry process.
The default is $\pm 5^{\circ}\text{C}$.

Maintenance Mode

- Maintenance Mode : It is possible to check the unit usage condition and maintenance check.
- How to access maintenance mode : Press the "Maintenance" button during default set mode (P20) to access maintenance mode and the display shown below will be displayed.

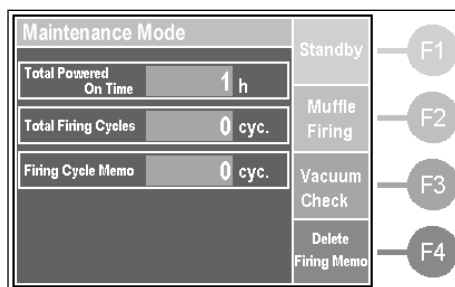

- How to use each maintenance

Unloaded Muffle Firing : Press the "Muffle Firing" button to start unloaded muffle firing.
See the "Precautions before use" (→P6) for more information.

Vacuum Check : You can check the vacuum pump ability and vacuum leak from this unit. Press the "Vacuum Check" button after the vacuum pump is connected and the muffle is at room temperature. It will display the screen below and the vacuum check will start. If you want to cancel, press the "Cancel" button to return back to maintenance mode screen. The check will take about 2 minutes.

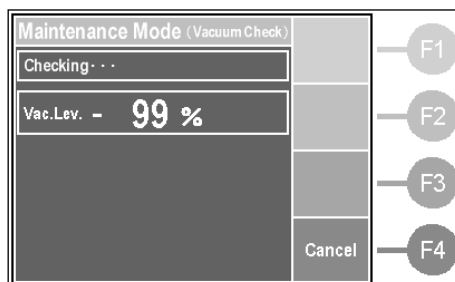

When the check is done, depending on the result the screens shown below will be displayed. If it is NG, check if the altitude setting is set correctly in default set mode (→P20). If the cause might be due to moisture, run the “Unloaded Muffle Firing” (→P7) and check one more time. Press the “Back” button to move to maintenance mode.

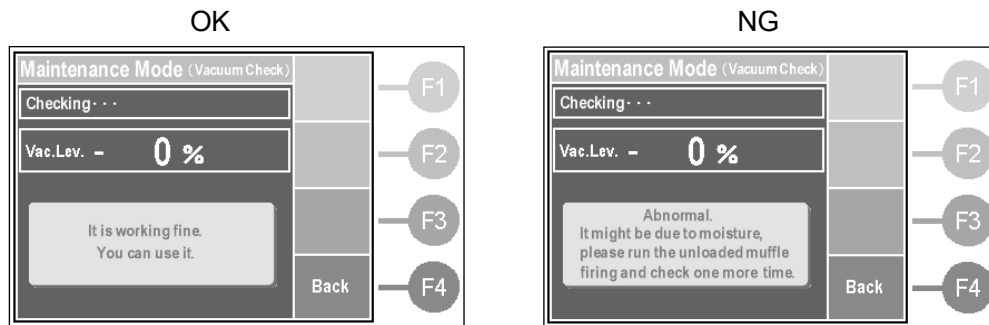

Total Powered on Time : It will display the total time the unit has been powered on since purchasing the unit. The measure is hour.

Total Firing Cycles : It will display the total amount of cycles run since purchasing the unit.

Firing Cycle Memo : It is possible to delete this firing cycle memo. Keep pressing the “Delete Firing Memo” button for 1 second to clear the firing cycle memo to 0. When exchanging muffle, keep record of when to change the muffle next. Then clear the firing cycle memo.

SD Card Mode

- On SD Card Mode : This is to write firing program data(s) from the unit to the SD Card or to read firing program data(s) from SD Card to the unit. It is possible to edit firing program data(s) with a computer.
- How to enter SD Card Mode : Press SD Card key to enter "Default Set Mode" (→P20) as shown below.

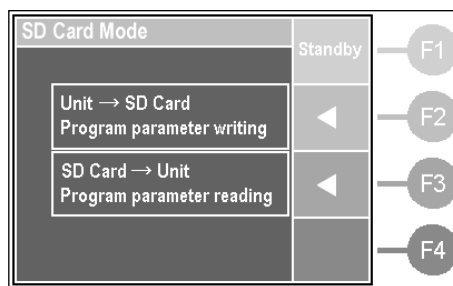

- How to use each item of SD Card Mode

Writing program content : Press F2 key to write firing program datas from the unit to SD Card.

The program firing datas are saved as "MPPRG.CSV" about course 0 to 499, "MPRG2.csv" about course 500 to 529.

It is possible to edit the file at a computer with EXCEL etc.

Reading program content : Press F3 key to read program firing data(s) from the SD Card to the unit as "MPPRG.CSV" and "MPRG2.CSV".

Note : The firing program will be saved the changes under this operation.

Periodic Machine Cleaning

Please perform the following cleanings on a weekly basis.



In case of a periodic machine cleaning, unplug the power cord from power outlet.

If cleaning the exterior of unit, dilute mild detergent and blot with soft cloth.

Firing Table

When the muffle and firing stand is cold, remove the firing stand and wipe with alcohol.

Maintenance Part Replacements



Make sure that main power is off and muffle heat is sufficiently low before you start.
This may cause fire or electric shock.

Temperature Sensor Replacement

1. Remove the 4 screws shown on drawing 1 to remove the left cover and right cover.
2. Remove the 4 screws shown on drawing 2 to remove the muffle cover.
3. Remove the 2 screws shown on drawing 3 to remove the red and white line connected to the temperature sensor.
4. Remove the 2 nuts shown on drawing 4 to remove the temperature sensor.
5. Install the new temperature sensor. We will complete installation by following the previous direction in reverse order.
Caution) The temperature sensor has polarity. Re-connect the red line to the "+" terminal and re-connect the white line to another terminal.
6. Once the replacement is complete, re-plug the power cord into the electrical outlet and power on the unit.
7. Check to see if the temperature rises. If the temperature lowers or display 0°C, the connection line to the temperature sensor is reversed. Please re-check.

- The replacement is complete. -

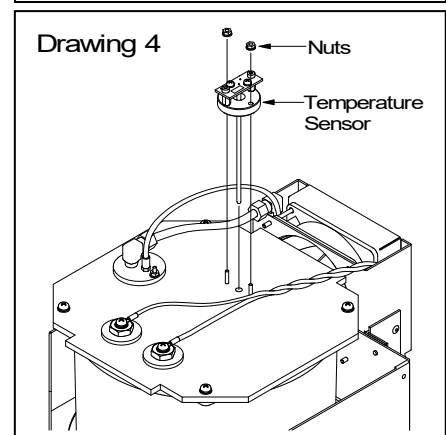
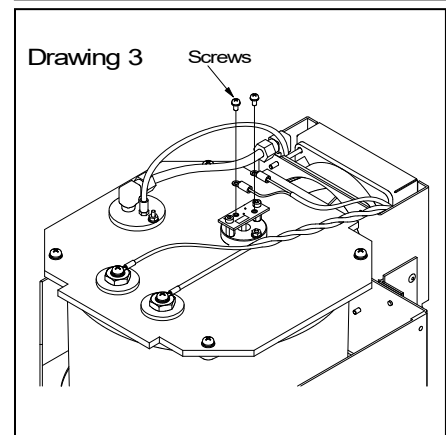
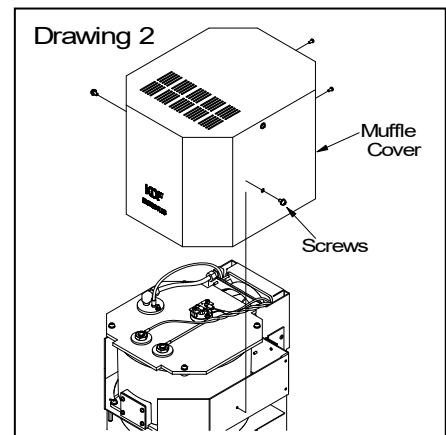
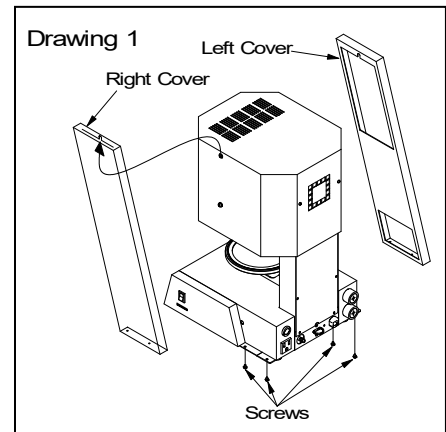

Muffle Replacement

1. Remove the temperature sensor. See the “Temperature Sensor Replacement” for more information.
2. Remove the 2 screws shown on drawing 1 to remove the white lines connected to the heater terminal.
3. Remove the 2 nuts shown on drawing 2 to remove the piping terminal.
※The replacement of piping is not required.
4. Remove the 4 screws shown on drawing 3 to remove the muffle.
5. Install the new muffle. We will complete installation by following the previous directions in reverse order.
Caution) Be sure to plug in the line securely to the end when re-connecting the line back to the heater terminal. If the line is not securely plugged in, it will become hot and dangerous.
6. Once the replacement is complete, re-plug the power cord into the electric outlet and power on the unit.
7. Check to see if the temperature rises. If the temperature lowers or display 0°C, it could possibly be that the connection line to the temperature sensor is reversed. Please re-check.
8. After replacement the new muffle, there may be instances where there is moisture inside the muffle. Before using, please refer and run the “Unloaded muffle firing”. →P7

- The replacement is complete. -

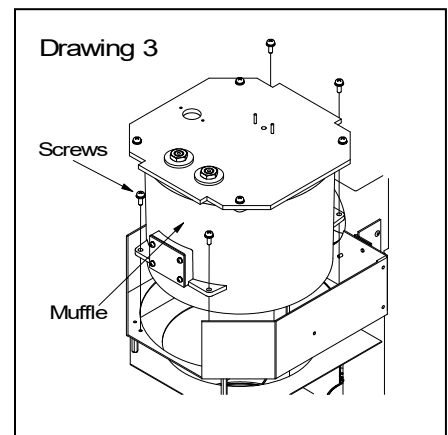
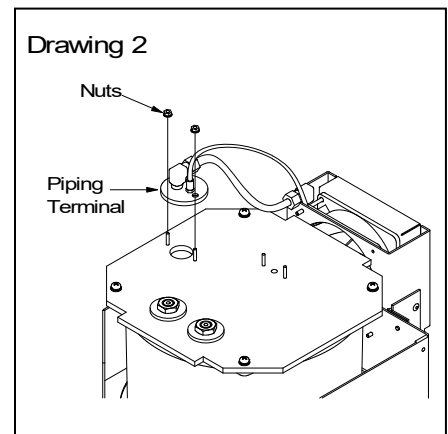
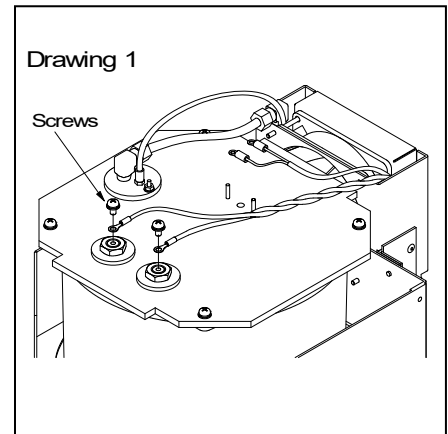

Error Messages

When the error codes shown below are displayed, address according to the message.

The following errors may sometimes be displayed in cases when there is extreme interference. Please turn off the unit and on again to see if the error code persists.

Caution) When the power is turned on and is fixed, there is still a possibility that the program or default setting has been erased or the values have changed.

The followings are considered to be possible sources of interference.

- Lighting strikes
- Introduction or arc casting machine in the vicinity
- Radio transmitter in the vicinity
- Induction motor in the vicinity

Error Messages

No. 2 Microcomputer is abnormal.

Displayed when the microcomputer operates abnormally due to noise.

No.3 Abnormal air release

Displayed when it takes more than 20 seconds from vacuum atmosphere to air release.

No.4 Abnormal movement of firing table

Displayed when the abnormal up/down movement of the firing table occurs.

No.5 Abnormal temperature rise

Displayed when the temperature does not rise or the temperature sensor is not working properly.

No.6 Abnormal temperature sensor

Displayed when the temperature sensor malfunction.

No.7 Abnormal vacuum creating

Displayed when the vacuum is not able to pull up to capacity value.

Try performing "Vacuum Check" in maintenance mode.

No.8 Abnormal memory

Displayed when the data in the memory has been corrupted and the reading and writing of memory is not working properly due to noise. When the power is turned off/on, it may be fixed but there is a possibility that program data may be erased.

No.9 Abnormal temperature rise in muffle

Displayed when the temperature of the muffle rises abnormally.

[WARNING!] Abnormal vacuum creating. No.7

Does not reach at set vac. lev.
Check out altitude setting. Also
moisture could be entering muffle,
pump could be weak or sealing
on table could be worn out.
Contact KDF.

Specifications

Product name	Master Plus
Power requirement	AC120V \pm 10% 50/60Hz
Power consumption	1300VA max.
Overall dimensions	260 (W) \times 432 (H) \times 312 (D) mm
Weight	15.2kg
Environment for setup	Indoor use Room Temperature 10~40°C Humidity 30~90%RH no condensing Altitude max. 2000m Pollution Degree 2 Over voltage Category II
Max. muffle temperature	1200°C
Inner muffle size	ϕ 93 \times 62mm
Programs storable	Auto. 530 courses, Manual 1 course
Safety Function	Cooling fan, Abnormal temperature monitoring circuit, 8 abnormal operation detection apparatuses
Option	Oil vacuum pump, Dry vacuum pump
Accessories	Firing Stand : 1pc Firing Tray Set : 1set Ceramic Tray Stand : 1pc Ceramic Tray : 1pc SD Card : 1pc Instruction Manual : 1booklet

DENKEN-HIGHDENTAL Co.,Ltd.

24-3 Kisshoin Ishiharakyomichi-cho, Minami-ku, Kyoto, 601-8356, JAPAN

TEL : 81-75-672-2124 E-mail : info@deken-highdental.co.jp